

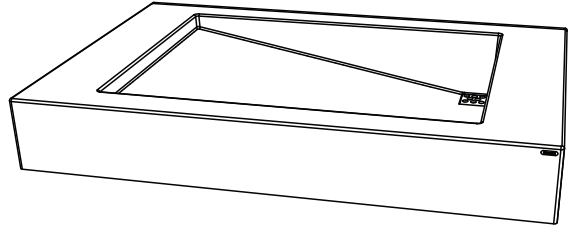

Gravelli

Technical drawing



SLANT 03 SINGLE

Wall-mounted concrete washbasin

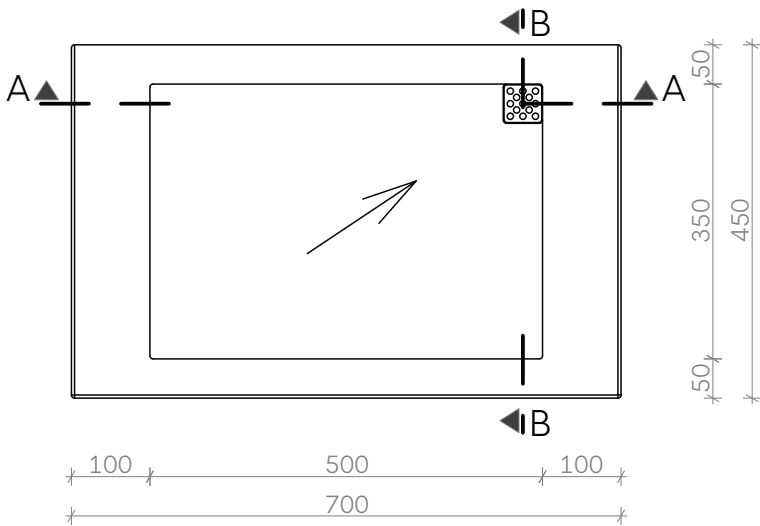

A - A

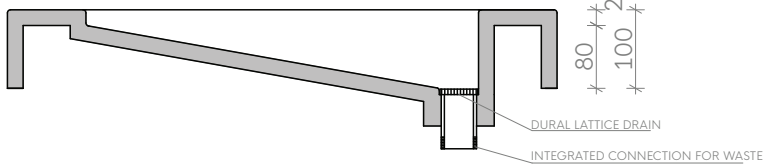

B - B VARIANT WITHOUT FAUCET MOUNTING HOLES

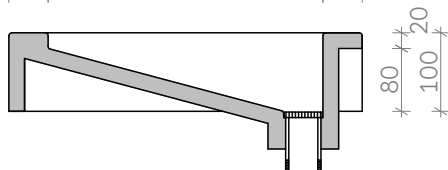
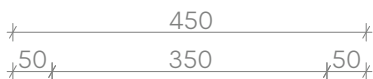

B - B - VARIANT WITH FAUCET MOUNTING HOLES

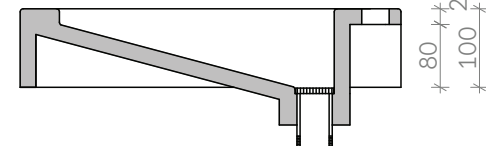
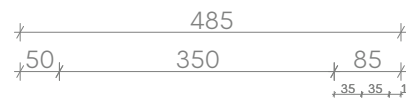

All product sizes are in millimeters and have an informative character. The producer reserves the right to amend the technical specification at any time without previous warning. This sink does not have an overflow hole. Valid from: 22.08.2017